



MTi11
Thermal Imager



INTRODUCTION

The MTi11 Thermal Imager is a compact handheld imaging camera used for predictive maintenance, equipment troubleshooting, and verification. Thermal images are displayed on the LCD and can be saved to internal memory.

The MTi11 comes with a Bluetooth instant share function, thermal images can be transferred to a smart phone to be analyzed, shared and reported quickly.

The MTi11 features:

- 120x120 pixel thermal imaging system.
- 6400 points real temperature fast measurements
- Hot, Cold, Center three temperature tracking function.
- 2" easy-to-read, bright graphical TFT display
- 50Hz fast Thermal image frame rate
- Bluetooth allows for images to be instantly shared & saved with iOS and Android smart devices
- Scene temperature range Lock function.
- LED flashlight function
- Up to 8 hours running time with rechargeable battery.
- Smart and compact design
- Rugged industrial design

Safety

International Safety Symbols



This symbol adjacent to another symbol, terminal or operating device indicates that the operator must refer to an explanation in the Operating Instructions to avoid personal injury or damage to the meter.

Cautions

Improper use can damage the meter. Please read and understand all of the information provided in this User Guide and other included documentation before use.

Refer to the **CAUTION** statement label (shown below) for critical safety information.

Quick Start Guide

The thermal imager is intuitive and easy to use; here are the basic steps (covered in more detail later in this Guide):

Press and hold the Power button for >2 seconds to power **ON**. The logo startup screen will appear followed by the thermal image display. If the battery requires recharging, refer to next page.

Point the unit toward the area or object of interest and view the thermal image. Relative temperature is represented by color, hot to cold (light to dark, respectively). The IR Temperature reading represents the temperature of the spot targeted by the Crosshairs, at the same time the hot and cold point temperature will be displayed on the screen.

Short trigger to freeze/capture the image. Press "**OK**" to save the image or press "**SHARE**" to share the image with smart devices. Trigger again to discard the image.

Press "**LOCK**" to Lock current scene temperature range, Press "**LOCK**" again to discard.

Powering and charging the thermal imager

Press and hold the power button for >2 seconds to switch **ON** the unit. A start-up screen (a thermal image) will appear, The unit is now ready to use; to switch **OFF**, press and hold for > 2 seconds. **Note:** that the **Auto Power OFF** function switches the unit **OFF** automatically after a programmed period of time.

With the power **ON**, the battery status icon  is located at the top left of the display.

When battery power is low, connect to an **AC** source or a computer **USB** port using the supplied **USB** cable (**USB** port is located at top of the unit).

With power **OFF**, the battery charging **Red LED** is **ON** when connected to an **AC** source or connected to a computer **USB** port. If the **Red LED** is **OFF**, it indicates the battery is full.

The unit can also be powered up and in use while charging in which case the battery symbol  is animated on the upper left.



The IR Thermal Imaging Display

1. Current Emiisivity setting
2. Battery indicator
3. Hot temperature point reading
4. Gold temperature point reading
5. Center crosshair
6. Cold temperature crosshair
7. Hot temperature crosshair
8. Frozen Image Icon
9. Center temperature point reading
10. "OK" button
11. "LOCK" button
12. Current temperature unit
13. Scene Low Temperature
14. Palette scale
15. Scene High Temperature
16. Time clock

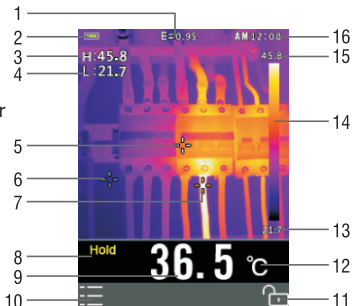

CONTROL BUTTONS AND TRIGGER

POWER/BACK/LOCK BUTTON

Press and hold >2 seconds to cycle the meter power **ON** or **OFF**; press once to exit a menu screen. Also used to lock the current scene temperature range (a soft "🔒" button will appear on the display above the button when this option is available).

OK/MENU BUTTON

Press once to access the Settings Menu, to confirm an edit, and to save an image when prompted (a soft "OK" button will appear on the display above the button when this option is available).

UP and DOWN NAVIGATION ARROW BUTTONS

Scroll the Settings Menu and select a menu item setting.

TRIGGER/LED Flashlight

Pressing the trigger once will take a snapshot of the current image. Pressing once again will discard the image and return to live image mode. Press and hold to open the LED flashlight, Press and hold again to close the LED flashlight.

Measure, Save, Delete, and Review IR Images

Point the thermal imager toward the object or area of interest.

Pull the trigger to capture the image. Press **"SAVE"** to save image. Press **"SHARE"** to share the image.

To review an image, access the Settings Menu (see Section 6).

To delete images from the internal memory, access the Settings Menu and delete the stored images as described in Section 6 Settings Menu.

Warning: All images are deleted when the internal memory is erased.

DESCRIPTIONS

Front descriptions

1. TFT Color Display
2. MENU-OK button
3. UP-DOWN arrow buttons
4. Lanyard access
5. POWER-BACK button



Back descriptions















6. LED Flash Light
7. IR Imaging lens
8. Trigger

Top descriptions

9. Battery Charging LED indicator
10. USB Battery charging interface



General Specifications

	Temperature units		Center crosshair
	Max temperature readings		Hot crosshair
	Minimum temperature readings		Cold crosshair
	Freezing image icon		Unlock icon
	12 time format		Lock icon
	IRON Color palette		Bluetooth icon
	Battery empty		Battery Full
			Battery charging

OPERATION

Switch ON the thermal imager

Press and hold for > 2 seconds to switch the unit **ON**. If the unit is sufficiently charged, the meter will display the start-up screen as shown below. The initial displayed image will show until the shutter resets the image. After the start up period, the unit will show a real time IR thermal image along with an IR Temperature reading. If the meter does not switch **ON**, please refer to Section "**Powering and charging the thermal imager**", for information regarding battery charging.

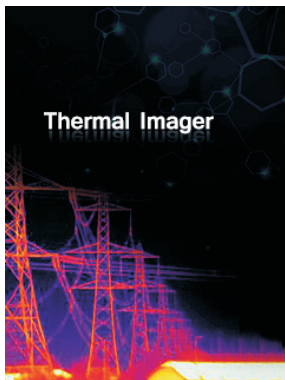

Lock/Unlock scene temperature level-span

1. The MTi11 comes with 120x120px detector that gives you 6400 pixels to clearly identify hotspots.
2. The temperature scale can be locked to highlight higher temperature in white. When the temperature is lower it is indicated in black.

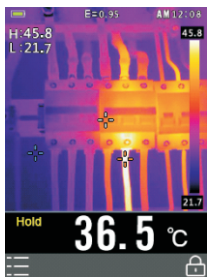

Pic 5-2 lock mode

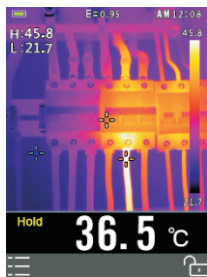

Pic5-3 unlock mode

1. Point the unit at an object or an area of interest.
2. Press the "🔒" button to lock the scene temperature range; the back color of the temperature readings will turn grey.
3. Press the "🔓" button again to unlock the scene temperature range.

Capture/Save Images using the Internal memory

The unit can store 20 images on internal memory. The saved images can be transferred to iOS, android and PC via Bluetooth.

1. Point the unit at an object or an area of interest.
2. Press the trigger to capture the image; the image will freeze.
3. If don't want to save the current image, press the trigger again and the image will unfreeze.
4. Press **"SAVE"** to save the image
5. If the image is stored successfully on the internal memory, the image will unfreeze.
6. To erase/format internal memory please refer to [Section 6 Settings Menu](#).

Share images using Bluetooth

Instant share

For quick analysis & reporting of thermal images, The unit has Bluetooth instant share function that works on iOS, Android and PC.

1. Enable the Bluetooth on the thermal imager.
2. Run Apps on smart devices, connect unit with smart device or PC (Detailed reference in "**Bluetooth connect**").
3. Point the unit at an object or an area of interest.
4. Press the trigger to capture the image; the image will freeze. The "**HOLD**" icon will appear on screen.
5. Press the trigger again, to discard and unfreeze the image.
6. Press "**SHARE**" to transfer the image.
7. If the image is transferred successfully to the smart device, the image will unfreeze.
8. Save, analyze, share or report the thermal images on smart devices.

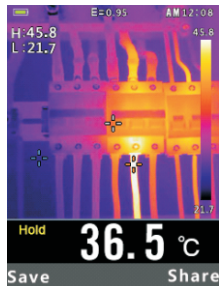

Pic5_4 Hold the image

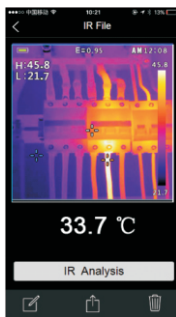
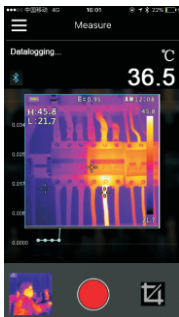

Pic5_5 Receive, analyse and save the image

Transfer the saved images

1. Enable the Bluetooth on the unit.
2. Run Apps on smart devices, connect unit with smart device or PC.
3. To access the Image Review mode, access the Settings Menu (Section-6) to review and delete images.
4. Press Trigger to share the current picture.
5. Press "**SHARE**" to transfer the image
6. Save, analyze, share or report the thermal images on smart devices.

Review/Delete Images

Use the Review Mode to view or delete stored images.

1. Access the Settings Menu (Section "**Settings Menu**") to review and delete images.
2. Press the back button to exit the image review mode
3. To delete all images, please access the Settings Menu as described in Section "**Settings Menu**" and reformat the SD card.

Lens and Imager Field of View

This table lists the horizontal FOV, vertical FOV and IFOV for the lens.

Focal Length	Horizontal FOV	Vertical	FOV/IFOV
7.5mm	21°	21°	4.53mrad

IFOV (Instantaneous Field of View) is the smallest detail within the FOV that can be detected or seen at a set distance, the unit is rad.

The formula is this: **IFOV = (Pixel Size) / (Lens focal length) ;**

D:S theoretical = 1/ IFOV theoretical) is the calculated spot size based on the pixel size of the Thermal Imager detector array and lens focal length.

Example: If Thermal Imager uses 9mm lens, because the Pixel Size of detector is 34um.

Horizontal FOV is 21°, Vertical FOV is 21°, the IFOV is 34um/7.5mm = 4.53mrad;

D:S theoretical (= 1/ IFOV theoretical) = 220:1

D:S measure = D:S theoretical /3= 74:1

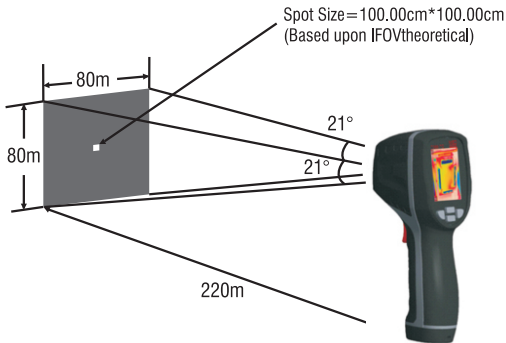

D:S measure (= 1/ IFOV measure) is the spot size needed to provide an accurate temperature measurement. Typically, D:S measure is 2 to 3 times smaller than D:S theoretical, which means the temperature measurement area of the target need to be 2 to 3 times larger than that determined by the calculated theoretical D:S.

Settings Menus

Using Settings Menu

Press the **OK** button to open the Settings Menus, as show below.

Press the **UP/DOWN** button to select a menu item or change the value of the current focus item.

Press the **OK** button to enter the submenu or set focus on the current selected item. Press the **ESC** button to return to the previous menu.

If want to exit settings menus, press the **HOLD** button or press the **ESC** button in root menu.

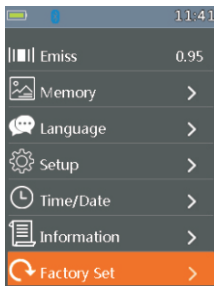

Settings details

Palette mode

The Thermal imager has five kinds of palettes, such as:



Press the **OK** button to select one of the display color palettes.



Temp Unit

Press the **OK** button to select this option and the color of option value will change to black **°C**. In focus state, use the **RIGHT/MENU** button to toggle **°C**, **°F** and **K**. Use the **ESC/OK** button to exit focus state and the color of option value will change white **K**.



Measure

Press the **OK** button to enter measure menu. Two selections are available:

Temp. Max and **Temp. Min**.

Press the **OK** button to set cur select item **ON** or **OFF**.

Temp.Max: This option enables thermal imager automatically detect the highest temperature point.

Temp.Min: This option enables thermal imager automatically detect the lowest temperature point.

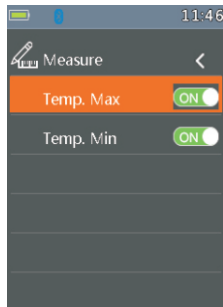

Emissivity

Press OK button to set focus on this option. In focus state, use UP /DOWN button to increase or decrease emissivity's value, use ESC / OK button to exit focus state. The available range is 0.01 to 0.99 in 0.01 steps.



Language

Press **OK** button toto enter language menu. Three options are available: Simplified Chinese, Traditional Chinese and English. Use **UP /DOWN** button to select language and use **OK** button to set selected language to be valid.

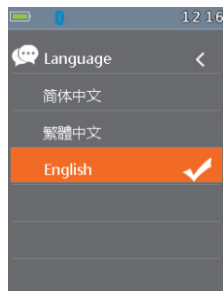

Setup

Press **OK** button to enter setup menu. Three options are available: Bluetooth, Brightness and Auto Off

Bluetooth: Use **OK** button to set bluetooth power **ON** or **OFF**.

Brightness: Press **OK** button to set focus on this option. In focus state, use **UP/DOWN** button to change LCD's brightness, use **ESC/OK** button to exit focus state. The available brightness's range is 100% to 10% in 10% steps.

Auto Off: Press **OK** button to set focus on this option. In focus state, use **UP/DOWN** button to choose the time period after which the meter enters the sleep mode.

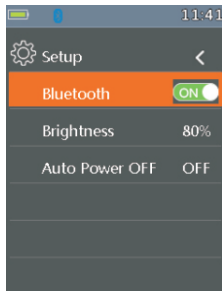

Bluetooth Connect

1. Turn on the Bluetooth function on the instrument.

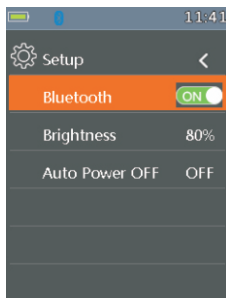

- Turn on the bluetooth of smartphone, press the icon "Thermview+" and enter into the home interface, Then press Connect Device icon on the Home interface, bluetooth device name will appear.

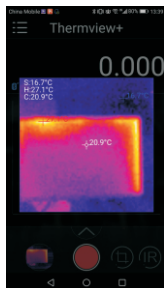

- Touch the device name listed in Bluetooth devices list to connect the device.

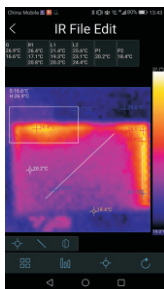

The detail information about Thermview+, please refer to Thermview+ APP help file.

Thermview+ for Android:

Please search in Google Play with keyword "Thermview+", download and run.

Thermview+ for IOS:

Please search in Apple store with keyword "Thermview+", download and run.

Time/Date

Press OK button to enter time menu.
In this menu, yeas, month, day, hour, minute and time format can be set. The changes take effect after exiting settings menus.

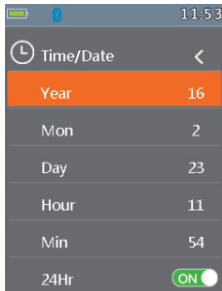

Memory

Press OK button to enter photo menu.
Two options are available: Photo Review and Delete Photo.

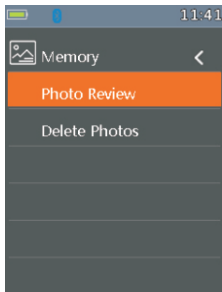

Photo Review: Press OK button to enter image browser function, and exit settings menus immediately.

Delete Photo: After Press OK button, dialog box will be displayed as show below.

WARNING: Select YES', will delete all the photos in 'RECORD' folder of the memory card.



Information

Press the **OK** button to enter system information menu. This menu contains the software's version, hardware's version and thermal imager's version.

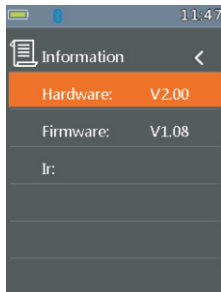

Factory Set

When select Factory Set option, after press the **OK** button, the dialog box will be displayed as show below. Select '**YES**', the system parameter will be reset.



Image Browser

In Image Browser mode. User can browse the pictures in 'RECORD' folder of the memory card. Press the **UP/DOWN** button to select previous or next picture. Press any other keys to exit Image Browser mode.

1. Current displayed picture's filename.
2. Current picture's index and total number of pictures.
3. Temperature. of center point.
4. Picture display area.

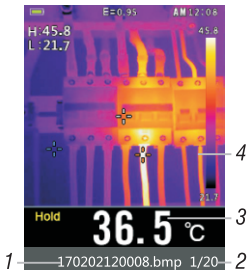

How to capture the screen when in the Thermal imaging mode

1. Use the **HOLD** button to enter **HOLD** mode, as show below.
2. Then press the **OK** button to capture the screen.
3. After saving to memory completely, the screen will exit **HOLD** mode.

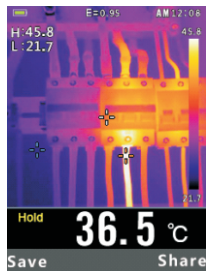

Technical specifications

IR Resolution	120x120 (6400 pix)
Field of view (FOV) / Minimum focus distance	21° x 21° / 0.5m
Spatial resolution (IFOV)	4.53mrad
Thermal sensitivity/NIETD	< 0.1°C @ +30°C (+86°F) / 100 mK
Image frequency	50Hz
Focus mode	Focus free
Focal length	7.5mm
Focal Plane Array (FPA)/ Spectral range	Uncooled microbolometer / 8-14 μ m
Object temperature range	-20°C to 380°C (-4°F to 716°F)
Accuracy	$\pm 2^{\circ}\text{C}$ ($\pm 3.6^{\circ}\text{F}$) or $\pm 2\%$ of reading (Environment temperature 10°C to 35°C, object temperature $> 0^{\circ}\text{C}$.)
Display	2" color TFT LCD screen,
Display resolution	240x320 pixels resolution
Battery	Rechargeable 3.7V (1300nAh) lithium ion battery (not user-serviceable)
Battery life	>6 hours, typical
Battery Charger	5V 1A USB charger (not include)
Drop Proof	Designed for up to 2 meters
Connect	Bluetooth BLE4.0, thermal image transfer and data logger.
Save image format	Bitmap (.bmp) with 6400 points temperature analyses and emissivity
Operating Temperature	-10°C to 45°C (14°F to 113°F)
Storage Temperature	-30°C to 55°C (-22°F to 131°F)
Allowable relative humidity	<80%HR
Storage temperature	-20° to 60°C (-4°F to 140°F)
Storage humidity	<80%HR



MAJOR TECH (PTY) LTD

South Africa

🌐 www.major-tech.com

✉ sales@major-tech.com

Australia

🌐 www.majortech.com.au

✉ info@majortech.com.au